

WE TAKE YOU TO THE TOP



# FIRE & RESCUE LADDERS

Easy  
Fast  
Safe



## RESCUE EQUIPMENT TO AUSTRIAN STANDARDS

With over 130 years of experience in supplying products to customers worldwide, JUST has continued to succeed in developing safe and easy to use ladders and climbing equipment.

Our rescue ladders set new standards for saving lives and combating disasters. Manufactured according to ÖNORM EN 1147 and its extension ÖNORM F 4047, these ladders guarantee the best quality according to Austrian standards.

### Type FO-700 Aluminium Extension Ladder 3-Part

- Tested and manufactured according to ÖNORM F 4047 and EN 1147 standards
- Built with flanged firefighting rungs (34 mm in diameter) which are securely milled to the rails
- Equipped with side mounted slide guides which reduce friction and allow for smooth extension with minimal pull-out force needed
- New ladder slide guides eliminate the need for guide brackets
- New rope brake design: immediately prevents the ladder from collapsing, as well as aids the ladder in folding smoothly
- New design allows for more stability with less weight
- Includes new lightweight stabiliser bar
- Suitable for a maximum load of 3 persons



Model No.	Number of Rungs	Length		Weight approx.
		folded	extended	
FO-717	3 x 17	5,60 m	12,0 m	80 kg
FO-719	3 x 19	6,20 m	14,0 m	84 kg

#### JUST WEB TIP

Get to know the correct handling of this product in our online video!

[lnk.justleitern.com/en/fo700](http://lnk.justleitern.com/en/fo700)



Stabiliser bar with reinforcement screws



Pointed support feet

FO-717  
Extension Ladder 3-Part  
with supports & stabiliser bar

## Type FO-600 Aluminium Extension Ladder 2-Part

- Tested and manufactured according to ÖNORM F 4047 and EN 1147 standards
- Built with flanged firefighting rungs (34 mm in diameter) which are milled to the rails
- Equipped with side mounted slide guides which reduce friction and allow for smooth extension with minimal pull-out force needed
- New ladder slide guides eliminate the need for guide brackets
- New rope brake: immediately prevents the ladder from collapsing, as well as aids the ladder in folding smoothly
- New design allows for more stability with less weight
- Suitable for a maximum load of 2 persons

Model No.	Number of Rungs	Length		Weight approx.
		folded	extended	
FO-615	2 x 15	4,70 m	8,00 m	30 kg
FO-617	2 x 17	5,30 m	9,00 m	33 kg
FO-619	2 x 19	5,90 m	10,00 m	36 kg



### JUST WEB TIP

Get to know the correct handling of this product in our online video!

[lnk.justleitern.com/en/fo600](http://lnk.justleitern.com/en/fo600)

Wall-running wheels

Rope brake

Side mounted slide guides

Extension aid and spiked ladder feet

FO-619  
Extension Ladder 2-Part



## ALUMINIUM SCALING LADDERS

JUST Scaling Ladders are characterized by their impeccable workmanship and versatility. The broad variety of accessories we carry makes these ladders a popular companion during firefighting operations.

Made from high quality alloyed aluminium, the one-side milled, welded square-profile rungs ensure a secure hold. The intuitive locking mechanism makes connecting and disconnecting the ladder parts straightforward and simple.

### Various Applications

#### Leaning Ladder

The classic use of the Modular Scaling Ladders with a maximum ladder length of up to 8.4 m.

2 variations:

- 4x F-101 module combined with a 2-rung attachment (F-102 or F-103)
- 3x F-101 module combined with F-105 base



#### A-Frame Ladder

The F-104 Connection Platform accessory can be used to combine 2 or 4 Scaling Ladder modules to form an A-frame. This can be used with the attached hook to rescue a person from a manhole or as a hose bridge (example photo on page 11).

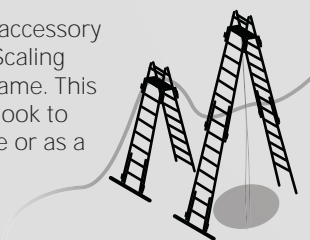

#### Trucksaver

The FG-106 extension can be used in combination with the Scaling Ladder modules to create a rescue platform.

The resulting platform can be used to rescue people from crashed vehicles.



#### Roof Ladder

With the patented F-120 Roof Hook, your Modular Scaling Ladder becomes a roof ladder in just a few easy steps. Compact storage as well as quick and simple installation, makes the roof hook a unique product which is exclusively manufactured by JUST Leitern AG.



Use as a roof ladder

F-120 Roof Hook

FW-100R-046

Hinging Spiked Steel Roof Hook

F-104 Connection Platform

Use as an A-frame for rescue from a manhole

## Type F-100 Aluminium Scaling Ladders

- Tested and manufactured according to ÖNORM F 4047 and EN 1147 standards
- Built with 28 mm deep, corrugated rungs
- Can be combined with all popular models
- Suitable for a maximum load of 2 persons



### JUST WEB TIP

Get to know the correct handling of this product in our online video!

[lnk.justleitern.com/en/f100](http://lnk.justleitern.com/en/f100)

## Base Module

Model No.	Number of Rungs	Length	Weight approx.
F-105	9	2,66 m	8,9 kg

## Attachment Module

- Equipped with a receded rung which allows for easy climbing when using as a base module
- Can be combined with F-103 and F-102 to create a base module

Model No.	Number of Rungs	Length	Weight approx.
F-101	7 (+1)	2,66 m	8,5 kg

## 2-Rung Attachment

- Used for additional stability and slip resistance
- Available with or without stabiliser bar

Model No.	Number of Rungs	Length	Stabiliser Bar size	Weight approx.
F-103	2	0,75 m	-	2,0 kg
F-102	2	0,85 m	1,2 m	4,5 kg

## Connection Platform

Model No.	Load Capacity	Weight approx.
F-104	300 kg	5,0 kg

## Roof Hook

- 2-Piece integral set that transforms a Modular Scaling Ladder into a roof ladder
- Foldable and easy to stow
- Includes rubber spacer to protect roof from damage
- Wheels make it easy to roll the ladder up the roof pitch to a secure hooked position

Model No.	approx. Weight	
	rubber spacer	roof hook
F-120	0,8 kg	8,5 kg
FW-100R-046 ◦	0,8 kg	8,0 kg

◦ ... This model is designed with a Hinging Spiked Steel Roof Hook. (see picture on the left)



F-105  
Base Module

F-101  
Attachment-Module



F-103  
2-Rung Attachment  
without Stabiliser Bar

F-102  
2-Rung Attachment  
with Stabiliser Bar



Use as a leaning ladder

## Trucksaver

- Since our Truck Saver follows EN 1147 as well as ÖNORM 4047 standards, the Scaling Ladder modules can be combined with those of any other manufacturer that follows these standards
- Built with anti-slip platform
- Load capacity of up to 300 kg
- Smallest necessary dimensions for easy transportation
- Lightweight and easy to set-up
- Set consists of: one pair of ladder connectors, horizontal bracing and the platform

Model No.	Transport Dimensions			Weight approx.
	Length	Width	Height	
FG-106	1,83 m	0,34 m	0,26 m	26 kg

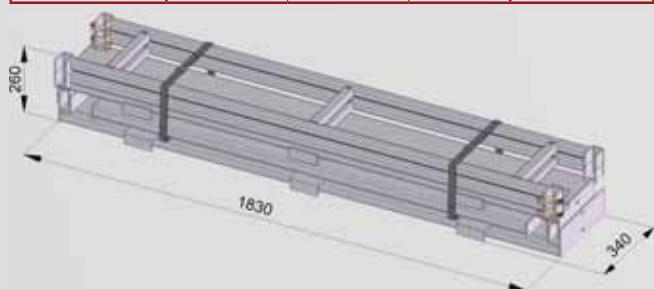

### JUST WEB TIP

Get to know the correct handling of this product in our online video!

[lnk.justleitern.com/en/fg106](http://lnk.justleitern.com/en/fg106)



### Other Accessories

Railing Attachment	
Model No.:	F-107
approx. Weight:	2,00 kg
<i>Additional railings</i>	
2-Piece Platform Levelers	
Model No.:	F-108
approx. Weight:	2,64 kg
<i>For use on uneven terrain. Up to 55 cm. in height difference.</i>	
Floodlight Attachment	
Model No.:	F-109
approx. Weight:	1,30 kg
<i>For easy installation of any standard floodlight.</i>	



Use as a rescue platform

## Type F-500 Aluminium Combination Ladder 3-Part

- Tested and manufactured according to ÖNORM F 4047 standards
- Multifunctional; can be used as a step ladder (A), free-standing ladder (B), as well as an extension ladder (C)
- Built with high quality aluminium alloy square-profile rails and 28mm square-profile rungs
- Suitable for a maximum load of 2 persons



Model No.	Number of Rungs	Length in m			Weight approx.
		A	B	C	
F-507	3 x 7	2,70	4,00	5,75	16,0 kg



F-507 Combination Ladder - 3-Part



## Type FG-110 Aluminium Hook Ladder

- Tested and manufactured according to ÖNORM F 4047 and EN 1147 standards
- Extremely lightweight yet durable profile
- Built with corrugated firefighting rungs (25 mm in diameter) that are securely milled to the rails
- Includes a foldable ladder support bracket
- Built with galvanized forged hooks. Includes:
  - Window spikes
  - Ring to hold carabiner and rope
- Total ladder width of 300mm (312mm with hook)
- Suitable for a maximum load of 1 person

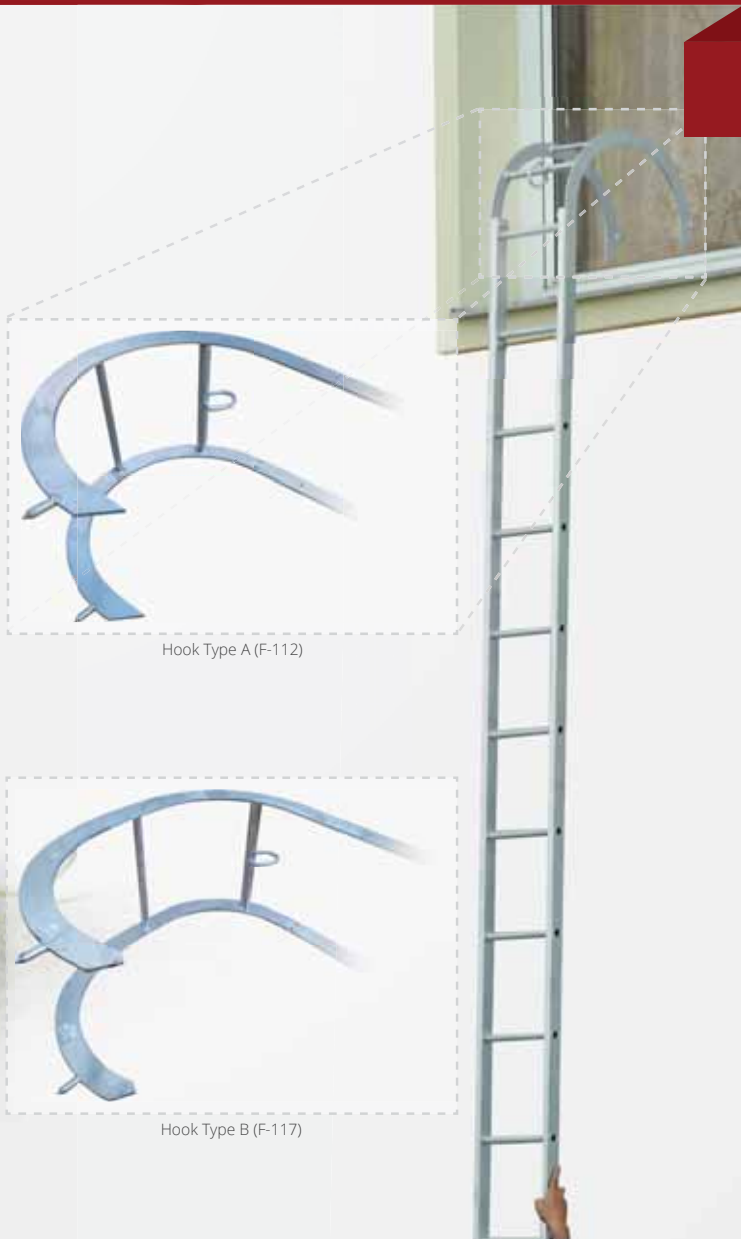

Hook Type A (F-112)

Hook Type B (F-117)

Hook Ladder Type A	
Model No.:	FG-110
Ladder Length:	4,20 m
Number of Rungs:	13
Hook Depth (a):	452 mm
Weight Hook:	5,5 kg
Weight Ladder:	7,5 kg
Total Weight:	13 kg
Hook Ladder Type B	
Model No.:	FG-115
Ladder Length:	4,80 m
Number of Rungs:	13
Hook Depth (a):	511 mm
Weight Hook:	6,0 kg
Weight Ladder:	8,0 kg
Total Weight:	14 kg



Foldable ladder support bracket



FG-110 Hook Ladder Type A

## RESCUE EQUIPMENT TO GERMAN STANDARDS

By way of our globally established experience in firefighting equipment, we have succeeded in developing ladders that are convenient and easy to use.

The following ladders are manufactured according to DIN EN 1147 and DIN Supplement 1. We guarantee faultless performance in agreement with these German standards. JUST is dedicated to designing and manufacturing reliable and efficient equipment so you can focus on what really matters - saving lives.

### Type FD-700 Aluminium Extension Ladder 3-Part

- Tested and manufactured according to EN 1147 and DIN Supplement 1 standards
- Built with 28 mm square profile reinforced rungs that are securely welded and milled to the rails
- Equipped with side mounted slide guides which reduce friction and allow for smooth extension with minimal pull-out force needed
- Includes rope brake which stops the ladder from collapsing immediately, as soon as there is no longer any pull on the rope
- Built with interchangeable insulated anti-slip plastic rung covers
- Suitable for a maximum load of 3 persons

Model No.	Number of Rungs	Length		Weight approx.
		folded	extended	
FD-717	3 x 17	5,6 m	14,0 m	70 kg

\* Also available as a 2-Part Extension Ladder (FD-619)

#### JUST WEB TIP

Get to know the correct handling of this product in our online video!

[ink.justleitern.com/en/fd700](http://ink.justleitern.com/en/fd700)

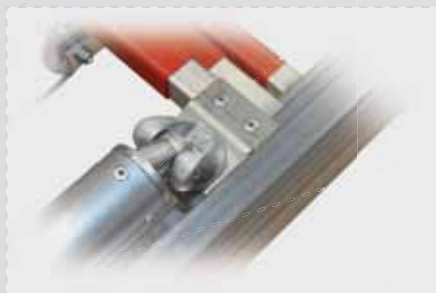

Stabiliser-ladder socket joint



Rope and pulley system

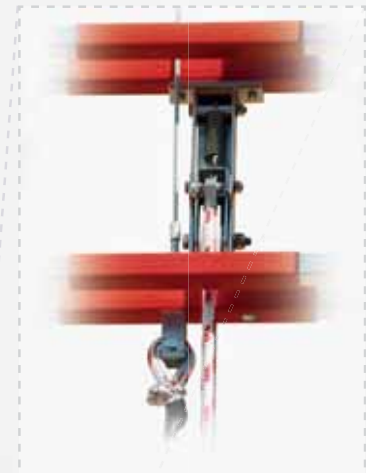

Rope brake



Supports with pointed feet



Side mounted slide guides

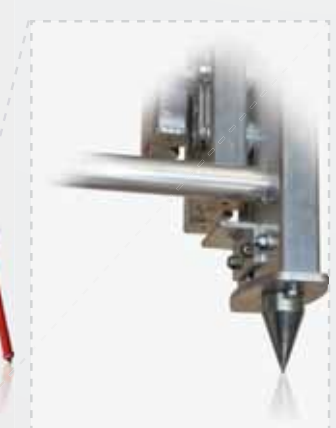

Extension aid and pointed ladder foot

FD-717  
Extension Ladder  
3-Part





Inward-folding hooks



Spring bolt



Peg for attaching mountable floodlight

**FE-501**  
Combination Ladder  
in free-standing pos.



**FE-501**  
Combination Ladder  
in extension ladder pos.

## Type FE-500 Combination Ladder

- Tested and manufactured according to EN 1147 and DIN Supplement 1 standards
- Ideal for rescue vehicles with limited space capacity
- Built with interchangeable insulated and anti-slip plastic rung covers
- Multifunctional; can be used as: stepladder (A), free-standing ladder (B), extension ladder (C), roof ladder, temporary light post, emergency bridge and hose guide
- Suitable for a maximum load of 2 persons



Model No.	Length			Weight approx.
	A	B	C	
FE-501	2,30 m	3,40 m	4,55 m	26,5 kg

Length A ... Stepladder  
Length B ... Free-standing ladder  
Length C ... 3-Part extension



### JUST WEB TIP

Get to know the correct handling of this product in our online video!

[lnk.justleitern.com/en/fe500](http://lnk.justleitern.com/en/fe500)

## Accessories for Model FE-500

### Stabiliser Bar

- Used to increase ladder stability
- Quick and easy to install

Model No.	Dimensions			Weight approx.
	Length	Width	Height	
FE-502	1,02 m	0,13 m	0,22 m	2,5 kg



**FE-502**  
Stabiliser Bar for FE-500

### Ladder Leveler (no image)

- Allows for ladder use on stairs or uneven ground
- Adjustable to suit environment; for a height difference up to 0.3 m

Model No.	Weight approx.
FE-504	2,0 kg

### Platform Attachment

- Quick installation onto the top two rungs when FE-500 is used as a stepladder
- Includes hooks to attach rope and pulley system for a shaft rescue

Model No.	Weight approx.
FE-503	1,2 kg



**FE-503**  
Platform Attachment  
(top and bottom view)

## ALUMINIUM SCALING LADDERS

JUST Scaling Ladders are characterized by their impeccable workmanship and versatility. The broad variety of accessories we carry makes these ladders a popular companion in firefighting services.

We use one-side milled corrugated rungs that are permanently welded to square-profile rails, which ensure a secure hold. Our ladders also use an intuitive locking mechanism which makes connecting and disconnecting the ladder parts extremely simple and timely.

To correspond with the new DIN addition, all ladders are equipped with insulated and anti-slip plastic rung covers.



### Various Applications

#### Leaning Ladder

The classic use of the Modular Scaling Ladders with a maximum ladder length up to 8,4 m.

2 variations:

- 4x FE-106 module combined with a 2-rung attachment (FE-102 or FE-107)
- 3x FE-106 module combined with FE-105 base part



#### A-Frame Ladder

The F-104 Connection Platform accessory can be used to combine 2 or 4 Scaling Ladder modules to form an A-frame. This can be used with the attached hook to rescue a person from a manhole (example photo on page 4) or as a hose bridge.

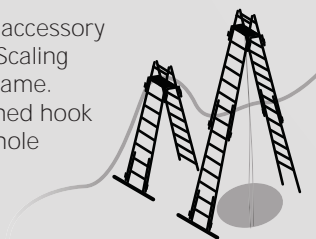

#### Truck Saver

The FG-106 extension can be used in combination with the Scaling Ladder modules to create a rescue platform. The resulting platform can be used to rescue people from crashed vehicles. (see page 6).



#### Roof Ladder

With the patented F-120 Roof Hook, your Modular Scaling Ladder becomes a roof ladder in just a few easy steps. Compact storage as well as quick and simple installation, makes the roof hook a unique product which is exclusively manufactured by JUST Leitern AG.



FE-106 Attachment Module



FE-105 Base Module



FE-102 2-Rung Attachment with Stabiliser Bar



FE-107 2-Rung Attachment without Stabiliser Bar



F-120 Roof Hook



FW-100R-046  
Hinging Spiked Steel  
Roof Hook

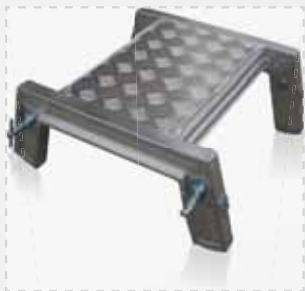

FE-104 Connection Platform

Use as  
hose bridge



Use as straight ladder

## Type FE-100 Aluminium Scaling Ladder

- Tested and manufactured according to EN 1147 and DIN Supplement 1 standards
- Built with interchangeable, insulated, anti-slip plastic rung covers
- Made with 28 mm corrugated square-profile rungs
- Can be combined with all popular models
- Suitable for a maximum load of 2 persons



### JUST WEB TIP

Get to know the correct handling of this product in our online video!

[lnk.justleitern.com/en/fe100](http://lnk.justleitern.com/en/fe100)

## Base Module

Model No.	Number of Rungs	Length	Weight approx.
FE-105	9	2,66 m	8,5 kg

## Attachment Module

- Can be combined with FE-107 and FE-102 to create a base

Model No.	Number of Rungs	Length	Weight approx.
FE-106	7	2,66 m	8,0 kg

## 2-Rung Attachment

- Used for additional stability and slip resistance
- Available with or without stabiliser bar

Model No.	Number of Rungs	Length	Stabiliser Bar size	Weight approx.
FE-107	2	0,75 m	-	2,0 kg
FE-102	2	0,85 m	1,2 m	4,5 kg

## Connection Platform

Model No.	Load Capacity	Weight approx.
FE-104	300 kg	5,0 kg

## Roof Hook

- 2-Piece integral set that transforms a Modular Scaling Ladder into a roof ladder
- Foldable and easy to stow
- Includes rubber spacer to protect roof from damage
- Wheels make it easy to roll the ladder up the roof pitch to a secure hooked position

Model No.	approx. Weight	
	rubber spacer	roof hook
F-120	0,8 kg	8,5 kg
FW-100R-046 ◦	0,8 kg	8,0 kg

◦ ... This model is designed with a Hinging Spiked Roof Hook. (see image)



## Type FEG-110 Hook Ladder

- Tested and manufactured according to EN 1147 and DIN Addition 1 standards
- Includes folding spiked steel hook (see image)
- Built with spacers on both rails
- Suitable for a maximum load of 1 person

Model No.	Number of Rungs	Length	Weight approx.
FEG-110	12	4,40 m	13,0 kg



FEG-110  
Hook ladder

## Type FE-130 Rescue Platform according to DIN 14830

The Rescue Platform is lightweight, easy to transport and quick to install. It is an excellent tool in the field of human rescue.

- Tested and manufactured according to DIN 14830 standards
- Load capacity of up to 500 kg
- Lightweight platform made for the rescue of people
- Platform tread made of non-slip material; safe to use in rain, ice and snow
- Height adjustable in 25 cm-step increments
- Each foot has a leveler to allow use on uneven terrain
- Includes attachable and foldable railing (for one side)
- Made with anti-slip plastic feet on all four platform legs
- Maximum height of 1,6 m
- 20 years of warranty

Model No.	Load capacity	Folded Dimensions in m			Weight approx.
		Length	Width	Height	
FE-130	500 kg	1,95	0,95	0,32	44,0 kg



FE-130 Rescue Platform  
according to DIN 14830

## Wheel Set for Rescue Platform FE-130

- For use on railway tracks
- Speedy assembly
- Includes 4 wheels on 2 axles

Model No.	Weight approx.
FEG-131	13,0 kg



FEG-131 Wheel Set for FE-130  
(for equipment transportation)

## RESCUE EQUIPMENT TO BRITISH STANDARDS

We also offer products and equipment for our British customers! The following ladders and climbing aids are according to both the European standard EN1147 and British standards.

Thus, they meet all the requirements of the British fire service and relief organizations.

### Type UK-TE Aluminium Extension Ladder 3-Part, rope operated

- Tested and manufactured according to EN 1147 and BS
- Built with 28 mm reinforced square-profile rungs that are milled and CMT welded to the rails
- Side mounted slide guide allows for smooth and easy extension with minimal force needed
- Built with an automatic rope brake for additional safety
- Suitable for a maximum load of 3 persons



Side mounted slide guides



Pointed support feet

Model No.	Number of Rungs	Length		Weight approx.
		folded	extended	
UK-TE-10.5	3 x 14	4,40 m	10,50 m	60 kg
UK-TE-12.5	3 x 18	5,70 m	12,50 m	89 kg
UK-TE-13.5	3 x 20	6,00 m	13,50 m	92 kg



#### JUST WEB TIP

Get to know the correct handling of this product in our online video!

[lnk.justleitern.com/en/ukte](http://lnk.justleitern.com/en/ukte)

### Type UK-TEP Aluminium Extension Ladder 3-Part (no image)

- Tested and manufactured according to EN 1147 and BS
- Built with 28 mm reinforced square-profile rungs that are milled and CMT welded to the rails
- Equipped with manual hooks
- Suitable for a maximum load of 3 persons

Model No.	Number of Rungs	Length		Weight approx.
		folded	extended	
UK-TEP-5.5	3 x 7	2,40 m	5,50 m	14 kg
UK-TEP-6	3 x 8	2,50 m	6,00 m	16 kg
UK-TEP-6.5	3 x 9	2,80 m	6,50 m	18 kg

UK-TE-13.5 Extension Ladder - 3-Part

## Type UK-DE Aluminium Extension Ladder 2-Part, rope operated

- Tested and manufactured according to EN 1147 and BS
- Built with 28 mm reinforced square-profile rungs that are milled and CMT welded to the rails
- Side mounted slide guide allows for smooth and easy extension
- Built with an automatic rope brake for additional safety
- Suitable for a maximum load of 3 persons

Model No.	Number of Rungs	Length		Weight approx.
		folded	extended	
UK-DE-9	2 x 18	5,5 m	9,0 m	43 kg
UK-DE-10	2 x 20	6,0 m	10,0 m	47 kg
UK-DE-10.5	2 x 21	6,3 m	10,5 m	50 kg

### JUST WEB TIP

Get to know the correct handling of this product in our online video!

[lnk.justleitern.com/en/ukde](http://lnk.justleitern.com/en/ukde)

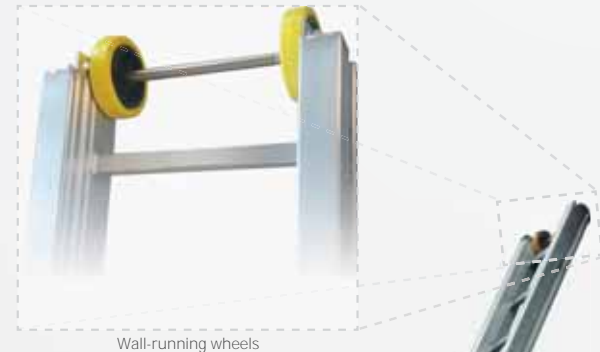

## Type UK-DEP Aluminium Extension Ladder 2-Part (no image)

- Tested and manufactured according to EN 1147 and BS
- Built with 28 mm reinforced square-profile rungs that are milled and CMT welded to the rails
- Equipped with manual hooks
- Suitable for a maximum load of 3 persons

Model No.	Number of Rungs	Length		Weight approx.
		folded	extended	
UK-DEP-4.5	2 x 8	2,7 m	4,5 m	10,5 kg
UK-DEP-5	2 x 9	2,9 m	5,0 m	12,5 kg
UK-DEP-5.5	2 x 10	3,3 m	5,5 m	14,5 kg
UK-DEP-6	2 x 11	3,6 m	6,0 m	16,5 kg

### JUST WEB TIP

Get to know the correct handling of this product in our online video!

[lnk.justleitern.com/en/ukdep](http://lnk.justleitern.com/en/ukdep)

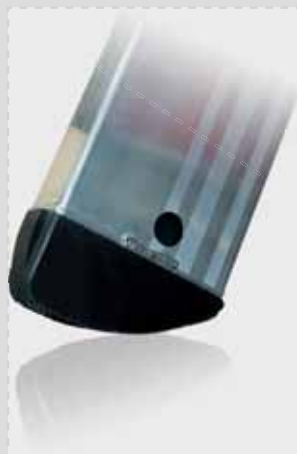





**UK-RLF-4.5**  
Foldable Roof Ladder

## Type UK-RL Aluminium Roof Ladder (no image)

- Tested and manufactured according to EN 1147 and BS
- Built with 28 mm reinforced square-profile rungs that are milled and CMT welded to rails
- Includes laser-cut, galvanized, roof hook that locks into position
- Suitable for a maximum load of 1 person
- Total ladder width of 290mm

Model No.	Number of Rungs	Length	Weight
UK-RL-4.5	13	4,5 m	13,0 kg
UK-RL-5	15	5,0 m	14,0 kg
UK-RL-5.5	17	5,5 m	15,0 kg
UK-RL-6	18	6,0 m	16,0 kg
UK-RL-6.5	20	6,5 m	17,0 kg

## Type UK-RLF Foldable Roof Ladder

- This model is like Type UK-RL with the addition of aluminium joints which allow it to fold for easy storage and transportation

Model No.	Number of Rungs	Length		Weight approx.
		folded	extended	
UK-RLF-4.5	13	2,50 m	4,50 m	14,0 kg
UK-RLF-5	15	2,75 m	5,00 m	15,0 kg
UK-RLF-5.5	17	3,00 m	5,50 m	16,0 kg
UK-RLF-6	18	3,25 m	6,00 m	17,0 kg
UK-RLF-6.5	20	3,50 m	6,50 m	18,0 kg



### JUST WEB TIP

Get to know the correct handling of this product in our online video!

[lnk.justleitern.com/en/ukrlf](http://lnk.justleitern.com/en/ukrlf)



**UK-ESFLW-3.5**  
Foldable for easy transportation

## Type UK-RLFW Wide Foldable Roof Ladder (no image)

- Like Type UK-RLF, but with a total width of 345 mm

Model No.	Number of Rungs	Length		Weight approx.
		folded	extended	
UK-RLFW-4.5	13	2,50 m	4,50 m	16,0 kg
UK-RLFW-5	15	2,75 m	5,00 m	17,0 kg
UK-RLFW-5.5	17	3,00 m	5,50 m	18,0 kg
UK-RLFW-6	18	3,25 m	6,00 m	19,0 kg
UK-RLFW-6.5	20	3,50 m	6,50 m	20,0 kg

## Type UK-ESFLW Foldable Aluminium Ladder

- Tested and manufactured according to EN 1147 and BS
- Built with 28 mm reinforced square-profile rungs that are milled and CMT welded to rails
- Joints lock into place and ensure a secure climb
- Can be used as both a stepladder and leaning ladder
- Suitable for a maximum load of 2 persons

Model No.	Rungs Number	folded	Length		Weight approx.
			step ladder	leaning ladder	
UK-ESFLW-2.5	4 x 2	0,65 m	1,16 m	2,50 m	10,0 kg
UK-ESFLW-3.5	4 x 3	0,95 m	1,72 m	3,50 m	12,5 kg
UK-ESFLW-4.5	4 x 4	1,24 m	2,27 m	4,50 m	15,0 kg
UK-ESFLW-5	4 x 5	1,39 m	2,55 m	5,00 m	17,5 kg

**UK-ESFLW-3.5** (Rendering)  
Use as a stepladder

**UK-ESFLW-4.5** (Rendering)  
Use as a leaning ladder

## DROP-DOWN LADDER RACK

The Gantry drop-down ladder rack is mounted onto the roof of the vehicle and is used to conveniently load and unload the ladder without needing to climb on top of the vehicle.

The JUST Gantry system can be used for any EN 1147, DIN EN 1147, BS EN 1147 or ÖNORM F4047 standard fire service ladder. It is also compatible with ladders that include a stabiliser bar or supports.

Manufactured from high quality corrosion and UV resistant materials such as stainless steel, aluminium and plastic.

- Roller bearing wheels allow for effortless operation
- Custom-made products for hoses, or equipment boxes available on request.

### JUST WEB TIP

Get to know the correct handling of this product in our online video!

[lnk.justleitern.com/en/gt000](http://lnk.justleitern.com/en/gt000)



### Type GT-100 Gantry for Ladders without Stabiliser Bar

- Profile length of 6,3 m
- Suitable for ladders at transport length of up to 6,2 m

Model No.	Suitable for
GT-110	Type UK-DE Extension Ladder 2-Part
GT-120	Type UK-TE Extension Ladder 3-Part
GT-130	Type FO-600 Extension Ladder 2-Part
GT-140	Type FD-700 Extension Ladder 3-Part
GT-100R	For all other types of ladders

### Type GT-200 Gantry for Ladders with Stabiliser Bar

- Profile length of 5,9 m
- Suitable for ladders at transport length of up to 6,2 m
- Roller bearing wheels allow for smooth and fluid gliding

Model No.	Suitable for
GT-210	Type FO-700 Extension Ladder 3-Part with Stabiliser Bar
GT-220	Type UK-TE Extension Ladder 3-Part with Stabiliser Bar
GT-200R	For all other types of ladders

### Type GT-300 Gantry

- Profile length 3,15 m
- Suitable for ladders at transport length of up to 3,5 m
- Roller bearing wheels allow for smooth and fluid operation

Model No.	Suitable for
GT-310	Type UK-DEP Extension Ladder 2-Part not rope operated combined with UK-RLF Roof Ladder
GT-320	Type UK-TEP Extension Ladder 3-Part not rope operated combined with UK-RLF Roof Ladder
GT-330	Type UK-RLF Roof Ladder
GT-340	Type F-100 Extension- or Type FE-100 Extension Ladder
GT-300R	For all other types of ladders or fire service accessories



GT-140  
Loaded with FD-717



GT-220 (Rendering)  
Loaded with Extension Ladder UK-TE



GT-320 (Rendering)  
Loaded with UK-RLF and UK-TEP

# REAR ACCESS LADDERS

## THE RIGHT CHOICE FOR ANY JOB

Each of our rear access ladders are uniquely made and measured to perfectly suit your requirements. From consulting and planning, to delivery and installation - all ladder parts are individually tailored to your needs.

High quality materials, proven manufacturing processes, and years of experience ensure excellent quality for every rear access ladder.

### Aluminium Rear Access Ladders

- Manufactured from high quality corrosion and UV resistant materials such as stainless steel, aluminium and plastic
- From the ladder's length to its function: we manufacture according to your needs and dimensions.

#### We're here for you!

We are eager to adapt our product to your specifications. Contact our customer service at [international@justleitern.com](mailto:international@justleitern.com) or +43(0) 2242 70 40 80 for further information.

Quotes available on request.



Example 1: With hinged section located on the bottom

Example 2: With hinged section and top platform



Example 3: Mounted on an emergency vehicle



Example 3: Ladder lowers completely

Example 4: Fixed alignment



## EXPERT ADVICE - WORLDWIDE

Whether you're over-seas or inland; thanks to our extensive network of customers and sales partners, we can offer you our fire service products and expert advice in 40 countries!

For more information, visit: [www.justleitern.com/international](http://www.justleitern.com/international).  
If you have further question, we're happy to help! Contact us at:  
[international@justleitern.com](mailto:international@justleitern.com) or +43(0) 22 42 1704 08-0

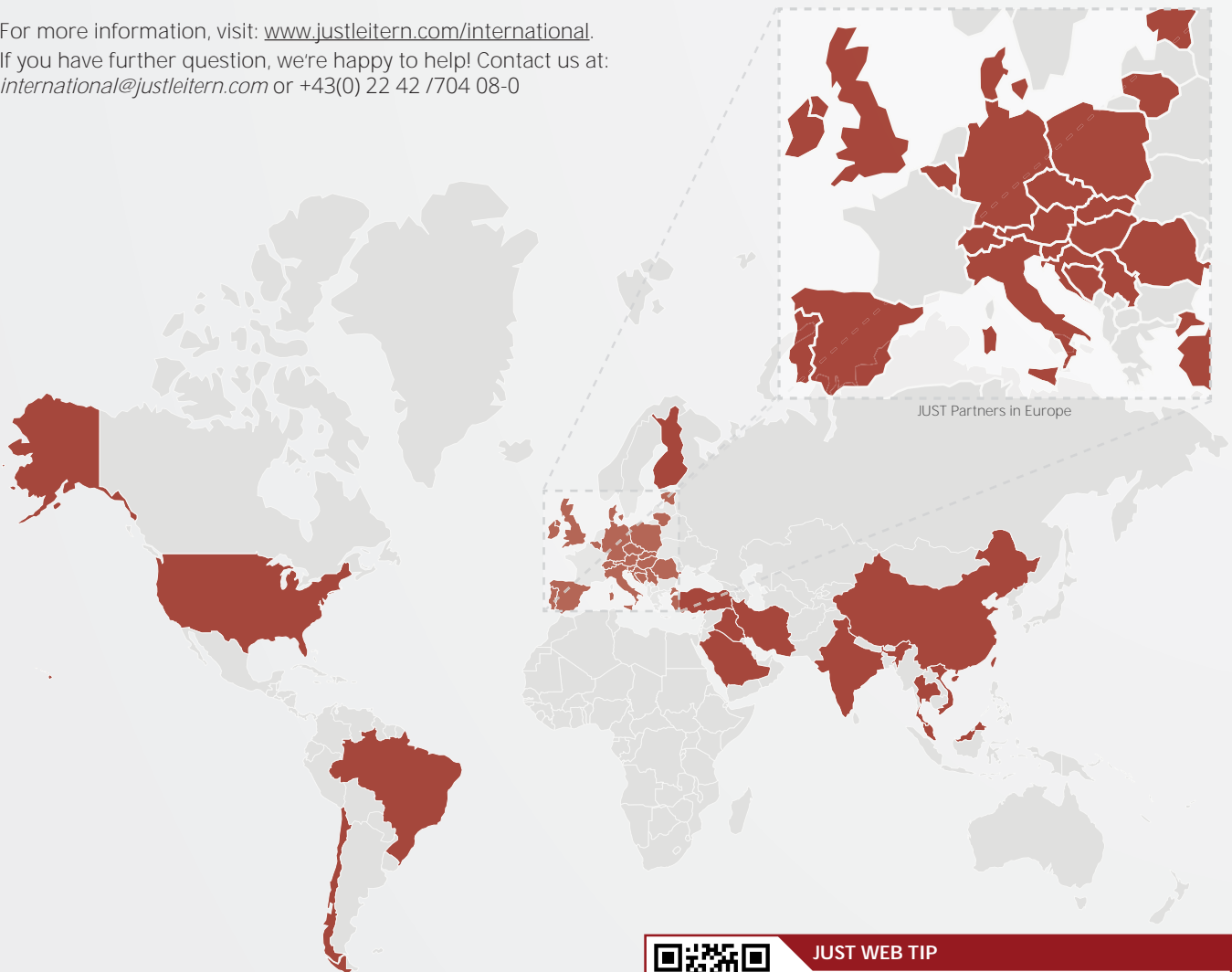

## JUST PARTNERS IN 40 COUNTRIES

### EUROPE

- Belgium
- Bosnia and Herzegovina
- Denmark
- Germany
- Estonia
- Finland
- Great Britain
- Italy
- Ireland
- Croatia
- Lithuania
- Malta
- Austria
- Poland

- Portugal
- Romania
- Switzerland
- Serbia
- Slovakia
- Slovenia
- Spain
- Czech Republic
- Hungary

### AFRICA / AMERICA

- Brazil
- Chile
- Mauritius
- USA

### ASIA

- China
- Hong Kong
- India
- Iraq
- Iran
- Malaysia
- Saudi Arabia
- Singapore
- Taiwan
- Thailand
- Turkey
- United Arab Emirates
- Vietnam



### JUST WEB TIP

You can find more information and contact details on our international partners by following the link below.

[link.justleitern.com/en/international](http://link.justleitern.com/en/international)

# JUST LEITERN AG

OVER 130 YEARS OF EXPERIENCE

JUST Leitern offers a world of safe and reliable climbing aids, stable scaffolding, customized solutions, state-of-the-art processing methods and innovative materials.

Versatility is our strength! JUST Ladders and scaffolds have assisted in the construction of family homes, the de-icing of airplanes, the bridging of lanes on race tracks, the cleaning of train cars, in modern glass constructions and even contributed to outer space missions. Fire departments all over the world use JUST ladders and trust in our long experience in the fire ladder industry.

With over 130 years of experience, JUST has become a reliable partner in the ladders business. Our company values trust with our customers as equally as motivating our employees.

Have questions about our extensive range of products? **Contact us!** We are happy to work with you to find the perfect solution for your individual needs.



## JUST IN TIME

- **1885 JUST Ladders in Vienna was founded**  
By 1889, logging for materials was taking place and used in the factory-made production of ladders, scaffolding and wooden equipment.
- **1914 JUST is awarded with the Royal Imperial Eagle**  
As a result of the recognition of first-class products, the company is awarded the Austro-Hungarian Royal Imperial Eagle.
- **1976 Transformation of JUST into an incorporated company**
- **1985 JUST is honoured with The Austrian Coat of Arms**  
JUST is once again honoured and awarded the Austrian National Coat of Arms in celebration of its 100th anniversary.
- **PRESENT**  
Today, JUST Leitern AG is a leading manufacturer and supplier of ladders and climbing aids that are qualified for any application. The factory and all branches in Austria and abroad offer expert advice and have a comprehensive stock to assist you with your business or personal project.



## OUR CORE SERVICES

A world of safe climbing-aids - contact us for more information!



### LADDERS

Strong and sturdy ladders in a variety of materials, such as wood, aluminium and plastic.



### SCAFFOLDING

Scaffolding products for both personal and industrial use. Construction and trestle scaffolding are available through our rental system.



### STAIRS

Stationary or mobile staircases and walking bridges designed and manufactured to suit individual needs.



### SPECIAL SOLUTIONS

From window cleaning suspension to custom solutions for space travel! The JUST designers are up to any task.



### FIRE LADDERS

JUST holds international recognition through its high safety standards in fire department products. Trust the market leader!

# JUST LEITERN AG - OFFICES

## **Zeiselmaier: Factory and Headquarters**

3424 Zeiselmaier, Bundesstraße B 14, Austria  
Tel. +43(0) 22 42/704 08-0, Fax. +43(0) 22 42/725 07  
E-Mail: international@justleitern.com

## **Tirol & Vorarlberg: Farben Morscher - Branch Rum**

6063 Rum, Kaplanstraße 1a, Austria  
Tel. +43(0) 512/262 288 400, Fax. +43(0) 512/262 288 409  
E-Mail: rum@farbenmorscher.at

## **Villach:** 9500 Villach, Untere Fellacher Straße 60, Austria

at the south-west bypass  
Tel. +43(0) 42 42/580 28, Fax. +43(0) 42 42/565 76  
E-Mail: justleitern.villach@speed.at

## **Graz:** 8055 Graz-Straßgang, Mühlfelderweg 40, Austria

Tel. +43(0) 316/29 74 00-0, Fax. +43(0) 316/29 72 29  
E-Mail: graz@justleitern.com

<https://www.justleitern.com/en>



Our deliveries operate exclusively in accordance with our General Terms and Conditions (GTC). The GTC can be requested by phone, email, or found on our website: [www.justleitern.com/en](http://www.justleitern.com/en).



Typographical, printing or technical errors are subject to change.  
UID-No. Austria: ATU14620800 | ARA-license number: 901 | DVR: 0091910  
Company Register: FN110833s | Jurisdiction: Vienna

As of August 2018